

CATÁLOGO

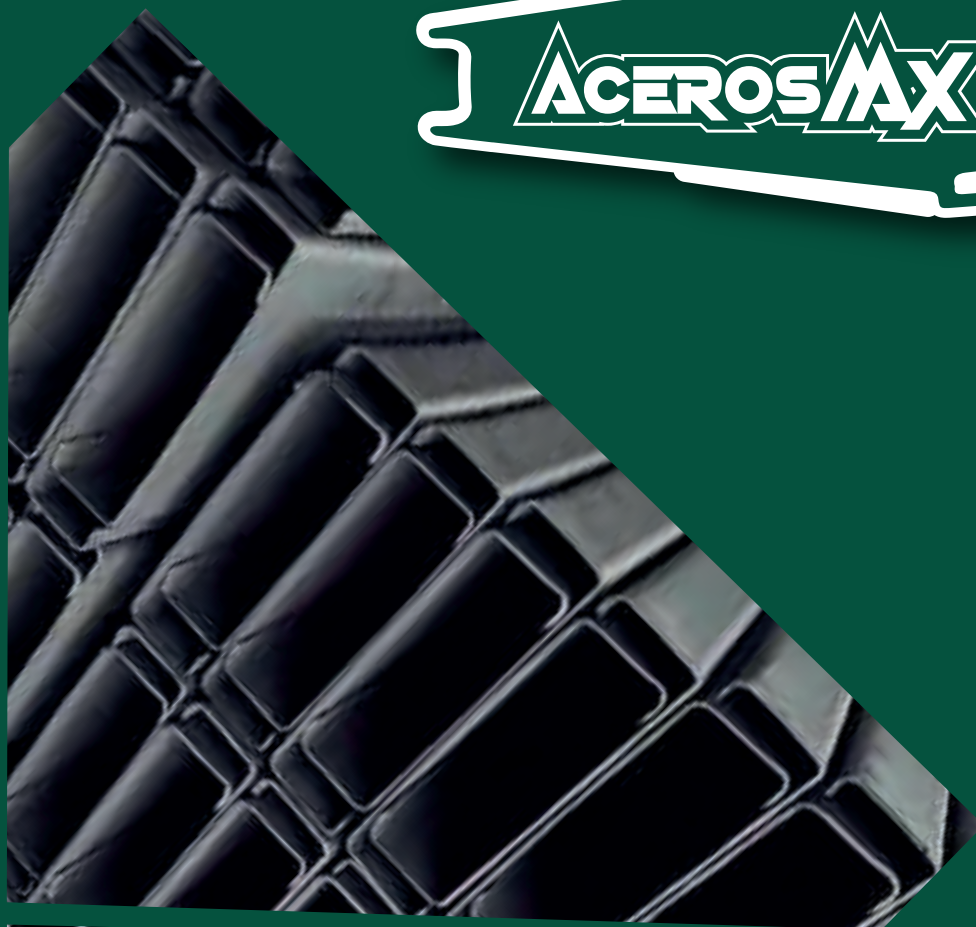

En este catálogo encontrará nuestros productos (de diversos tipos y medidas) Manteniendo constantemente nuestra existencia, para darle un mejor servicio a nuestros clientes.



PERFILES

PTR

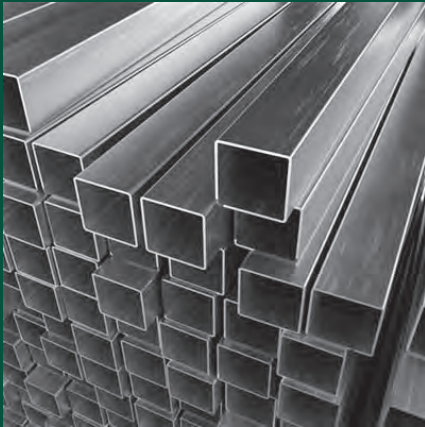

PERFIL

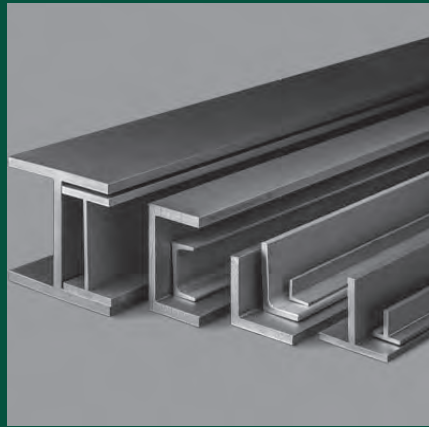

SOLERA

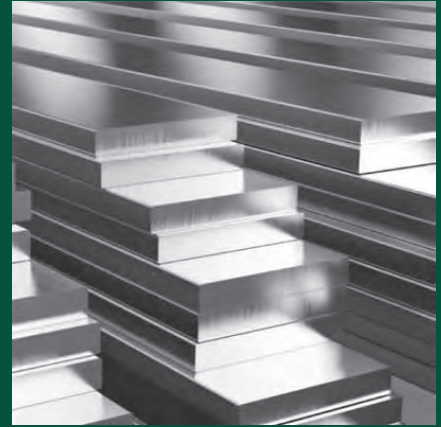

ANGULO

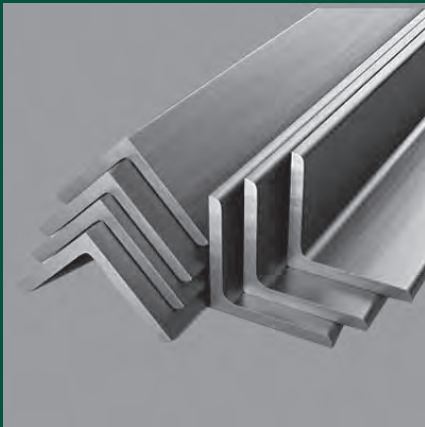

LAMINA

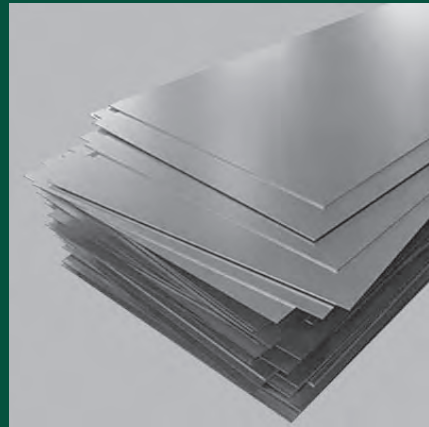

PLACA



TUBO



CANAL

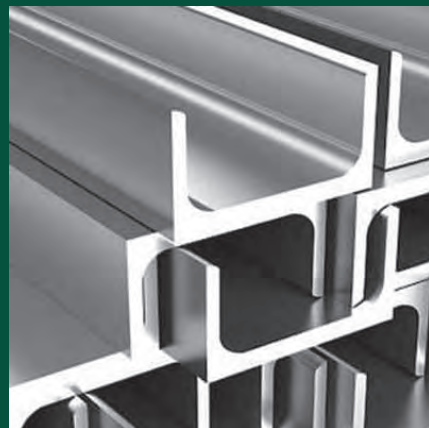

VIGA





(Redondo, placa, solera)

ACERO CARBÓN

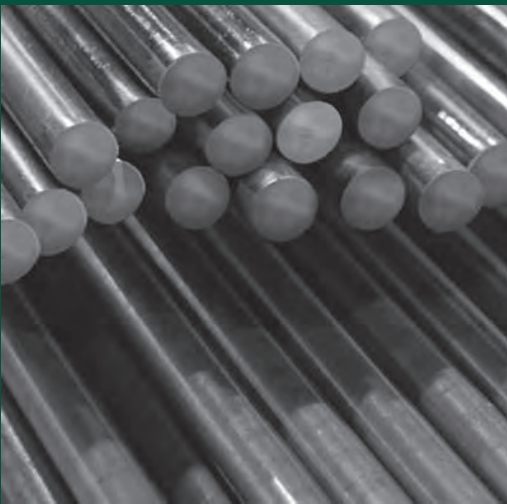

ACERO MAQUINARIA



ACERO INOXIDABLE



BARRA HUECA





METALES

(Redondo, placa, solera)

BRONCE

HIERRO

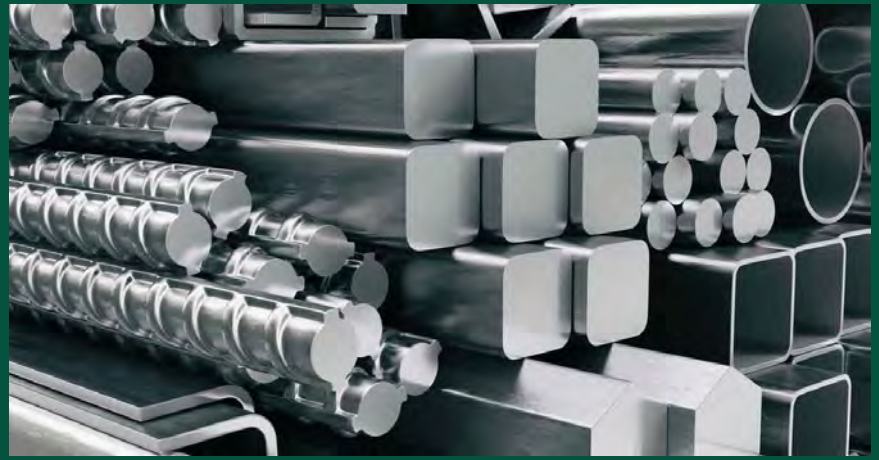
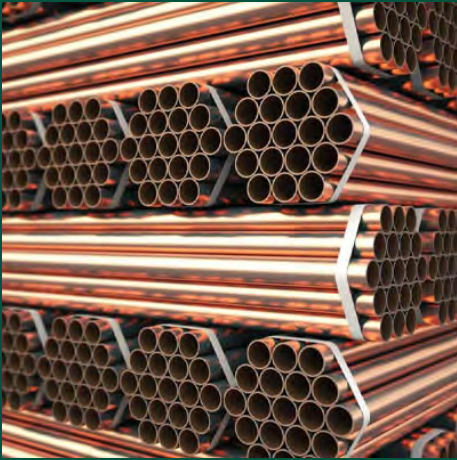

ALUMINIO

LATÓN



**PLÁSTICOS
INGENIERIA**



FUNDICIÓN

(De acuerdo al molde)

ACERO

BRONCE



HIERRO

ALUMINIO

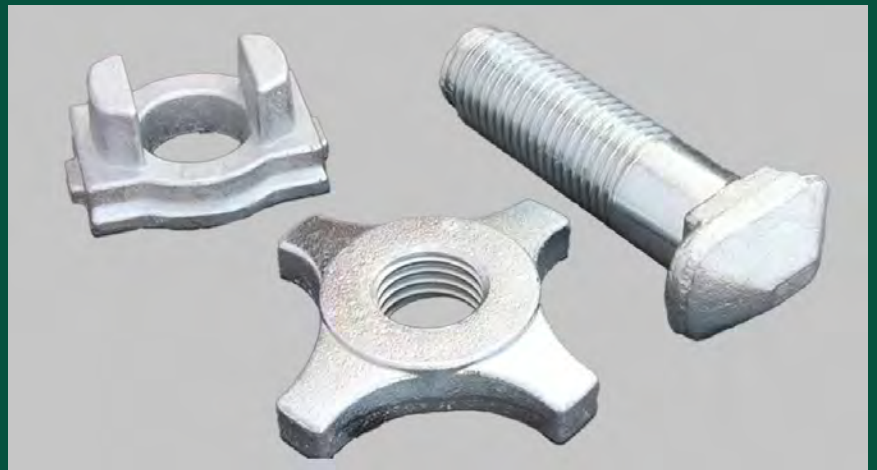

**COLADA
CONTINUA**